

## OVERZICHT HALFGELEIDERS

TS 1	AF 124	HF-versterker FM
TS 2	AF 125	Oscillator en menggedeelte FM
TS 3	AF 126	Oscillator en menggedeelte AM tevens versterker FM
TS 4	AF 126	MF-versterker
TS 5	AF 126	MF-versterker
TS 6	AC 126	LF-versterker
TS 7	AC 125	Eindversterker
TS 8,9	2-AC 128	Eindversterker
GR 1	AA 119	Begrenzer
GR 2	BA 102	Regeldiode AFR
GR 3	AA 119	Regeldiode AVR
GR 4,5	2-AA 119	Detector FM
GR 6	AA 119	Detector AM

## CODENUMMERS

Kast	4822 116 00946
Achterwand	4822 116 00947
Rooster in achterwand	4822 107 00626
Batterijdeksel	4822 107 00696
Schroef, bevestiging batterijdeksel	4822 105 00843
Handvat	4822 116 00945
Bevestigingsbeugel voor handvat	4822 106 00331
Batterijhouder	4822 105 00842
Beugel met contrastekers	4822 105 00839
Lens	4822 162 00501
Snaarwiel	A3 680 02
Bus op as afstemcondensator	4822 106 00333
Bus op as FM-eenheid	4822 106 00334
Knop (geluidsstrekte, klank)	4822 160 00235
Knop (afstemming FM-AM)	4822 160 00236
Druktoetseneenheid (3-5)	4822 105 00855
Druktoetseneenheid (6-9)	4822 105 00844
Druktoets (3-9)	4822 107 00697
Lamphouder	A3 311 15
Telescoopantenne	4822 106 00328
Oortelefoonaansluiting	4822 211 00965
Schroef bevestiging oortelefoonaansluiting	A3 715 60
Plastic pen bevestiging HF-printplaat	4822 162 00503
Schaal	4822 110 00398
Ferroceptor LG-MG	4822 106 00337
Ingangstransformator	4822 107 00186
Uitgangstransformator	4822 107 00185
Variabele condensator	49 002 57
Geluidsstrektegelaar R31/R32	4822 071 00527
Klankregelaar R34	4822 071 00528
VDR-weerstand R56	4822 071 00944
Verlichtingslampjes L1,2	7121 D/00
Verlichtingslampje L3	7111 D

## BEDIENINGSORGANEN

1. Geluidsstrekte (R31/32)
2. Klank (R34)
3. Schaalverlichting en batterijcontrole
4. Batterijschakelaar
5. AFR-schakelaar
6. LG-schakelaar
7. MG-schakelaar
8. KG-schakelaar
9. FM-schakelaar
10. Batterijcontrole
11. Afstemming FM
12. Afstemming AM

## SPECIFICATIE

Langegolf	2000 - 1150 m (150 - 260 kHz)
Middengolf	580 - 185 m (517 - 1622 kHz)
Kortegolf	50,8 - 24,8 m ( 5,9 - 12,1 MHz)
FM	3,45 - 2,97m ( 87,5 - 104 MHz)
Luidspreker	AD 3576 RX, 4 ohm, 6 W
Voedingsspanning	6 V (4 x 1,5 V)
Verbruik	92 mA
Uitgangsvermogen	860 mW
Afmetingen	20 x 31 x 9 cm

## AANSLUITINGEN

Buitenantenne  
Oortelefoon

PRINCIPESCHMA pagina 113

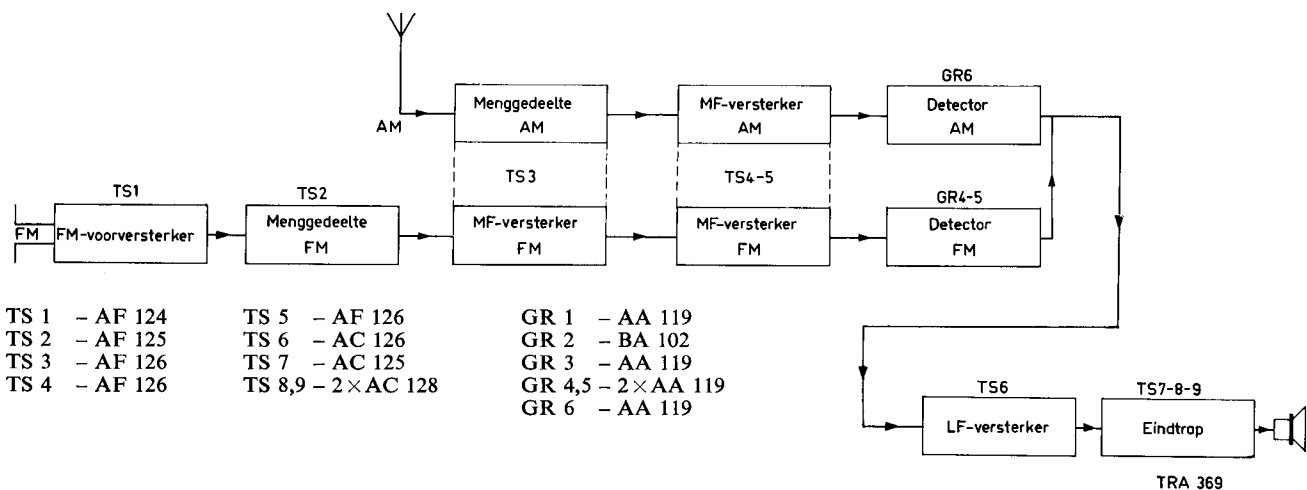

S	B	C	D	A	G	E	F	K	J	H	V	L	M	U	W	N	O	R	T	P	S																								
C	7	4	5		77	6	19	21	18	76	16	20	23	10	22	78	12	9	56	55	48	13	24	46	47	59	29	53	54	31	25	44	45	28	52	57	34	50	51	33	32	43	38	35	
R					2		3				27				1	26	23	12	24	4	22			6	21	8	15	19	16	20	25	19	16	17			15	10	7	13	11			14	9

L 5 W 44 T

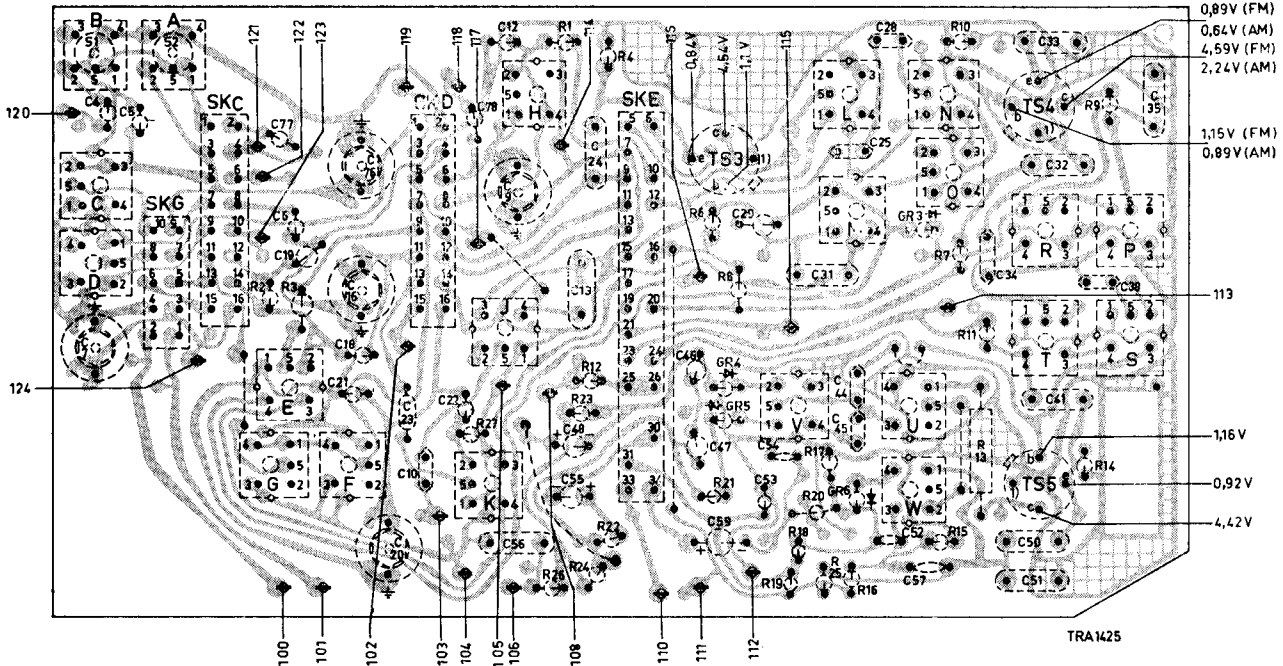

S	C	104	105	106	107	A.B		
C	102,112,104,107	101	109,108	106	114,111,110,115,105,103,113	120	119,117	116
R		102		104,103,101		106		105

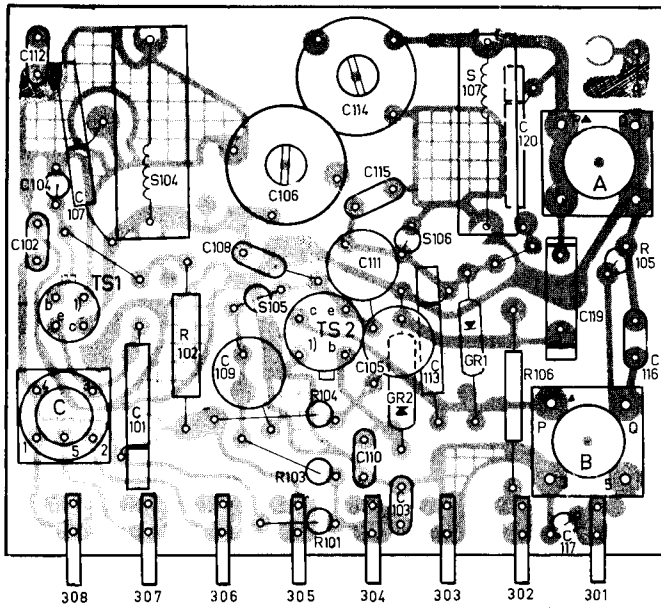

TRA374

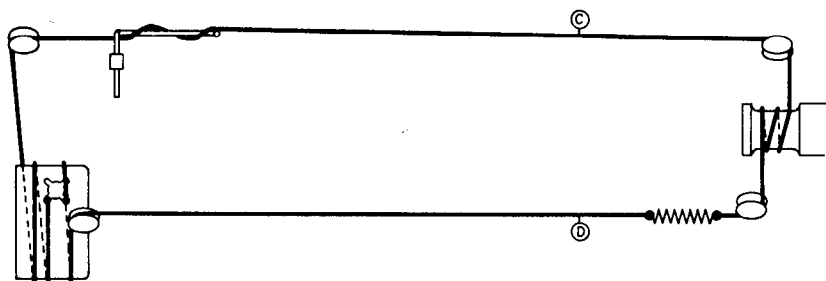

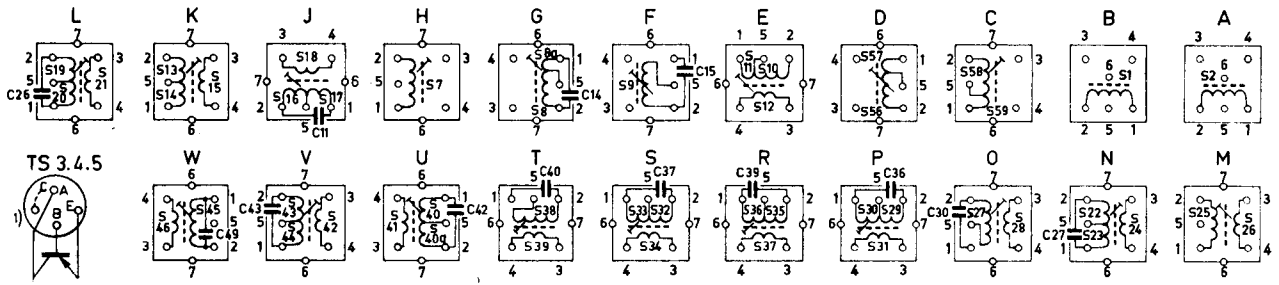

TRA362 A

S	55	52	50	51	53	54																		
C	67						71	66	74	68	65	69	70	75	64	60	63	61						
R	49						44	45	48	47	53	40	50	42	52	36	39	37	45	43	51	35	30	38

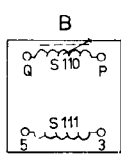
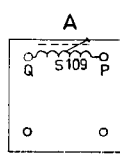
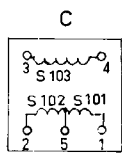
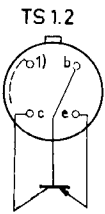
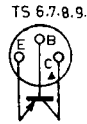
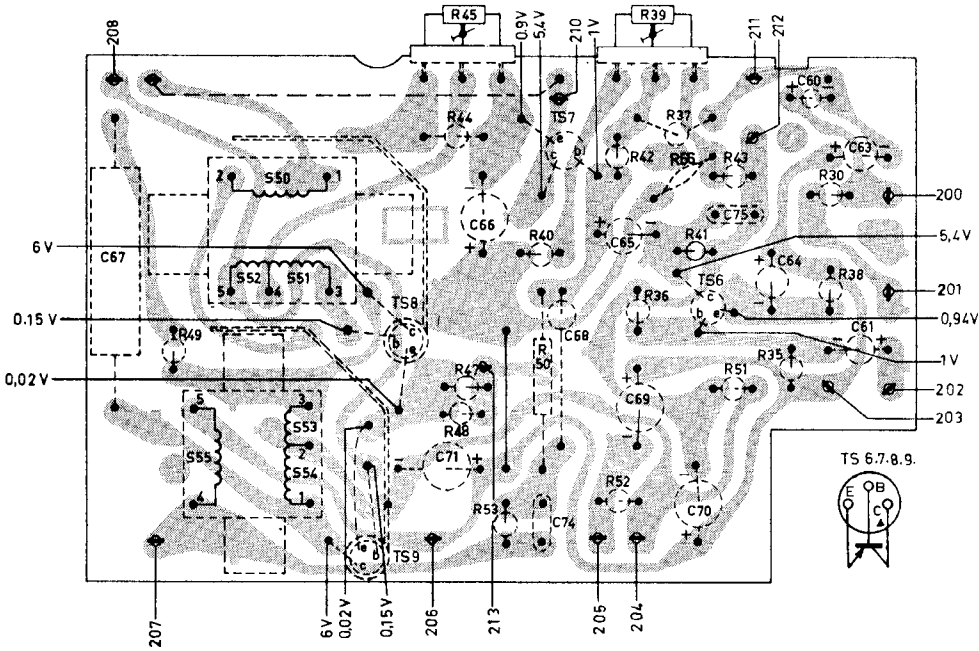

TRA1626 A

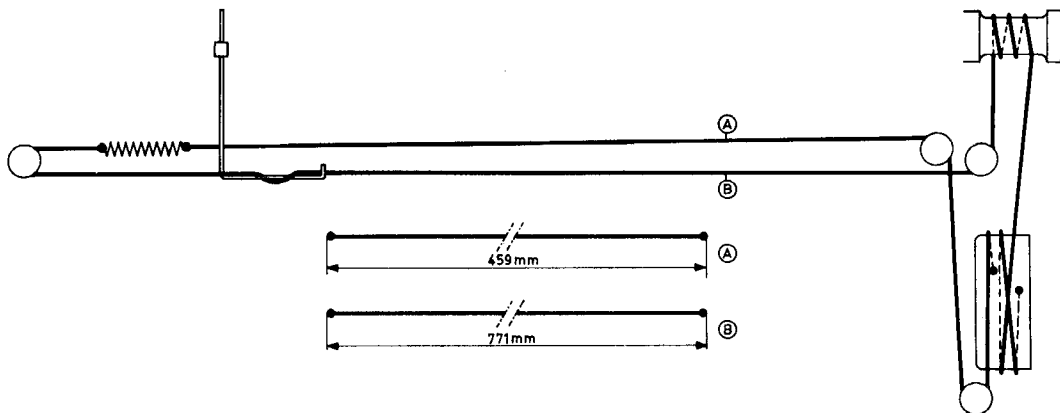

# SCHEMA L 5 W 44 T

S	61. 1. 2.	101. 102. 103.	7. 56. 57. 58. 59.	104.	105.	110.	111.	106.	109. 107.	3. 4. 5. 6.	62. 8. 9a. 9.	16. 17. 18.	25. 26. 20. 19. 21. 13. 14. 1.
C	4. 76. 3. 6.	78.	9. 101. 102. 103. 12. 5.	106. 107. 108. 109. 104. 73. 69. 70. 71. 116. 1. 110. 105.	117. 111.	113. 119. 7.	120. 115. 114. 6. 72. 112. 77.	56.	14.	10. 15.	11.	13. 2.	31. 29. 25. 26. 24. 22. 20. 21. 11.
R		101.	102.	103.	104. 105.	51. 52. 106.	33.		55. 12.		1.		3. 6. 4. 27. 2.

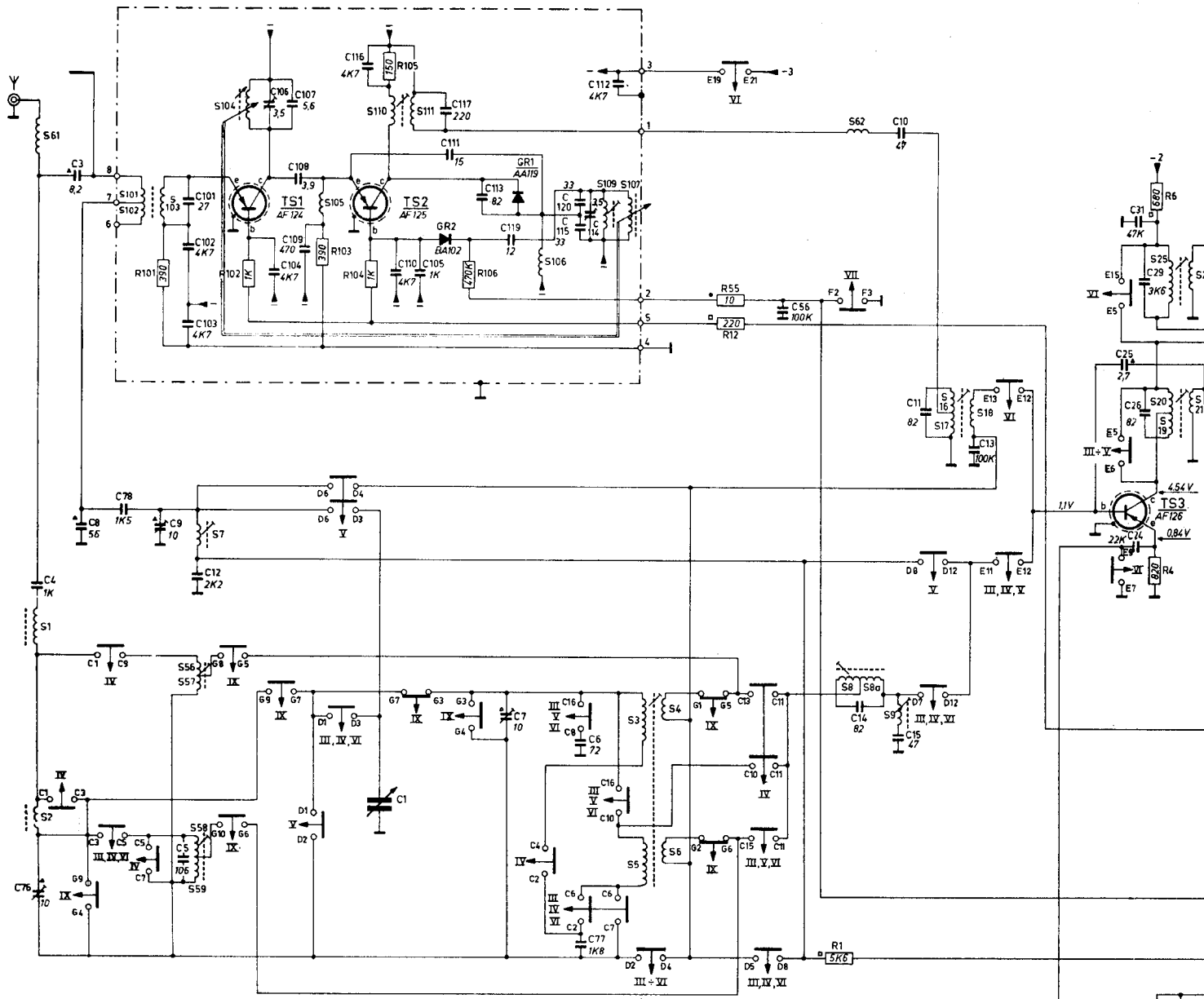

- 902/A...
- 902/K...
- 906/L.
- 904/P
- 904/I
- 908/P

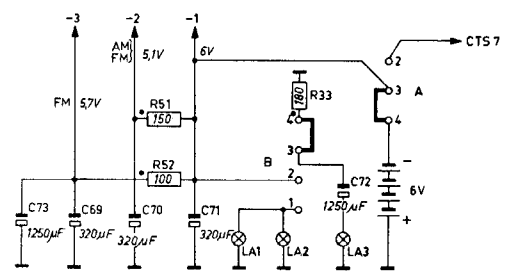

SK	B  → II	A  → I	F  → VII	→ III	C  → IV	D  → V	E  → VI
function	batt check +dial illum	on /off	AFC	LW	MW	SW	FM

SKG |→ VIII : ferroceptor / extern aerial Switch

16, 17, 18.	25, 26, 20, 19, 21, 13, 14, 15, 10, 11, 12.	27, 28, 22, 23, 24.	35, 35, 37, 30, 29, 31.	38, 39.	32, 33, 34.	45, 46, 40a, 40, 41.	42, 44, 43.	50, 51, 52.	53, 54, 55.
11.	13, 2.	31, 29, 25, 26, 24, 22, 20, 21, 18, 16, 19, 28, 27, 30.	32.	34, 39, 36, 33, 35, 62, 60, 38, 37, 40, 61.	63.	44, 49, 51, 41, 42, 75, 64, 65, 50, 45, 66, 52.	43.	57, 47, 46, 68, 53, 48, 74.	54, 59, 55, 67.
		3.	6.	4, 2, 7.	7.	8, 9, 10, 34.	30.	31, 32.	36, 35.
						11, 41, 38.	37.	25, 13, 14, 43, 39, 40, 47.	44, 45, 16, 15, 21.
									50, 17, 18, 19, 24, 23, 26, 47, 48, 20, 22, 49, 53.

